

PROFESSIONAL

CHICAGO ELECTRIC®
POWER TOOLS

VARIABLE SPEED MULTI-FUNCTION TOOL

Model 67537

SET UP AND OPERATING INSTRUCTIONS

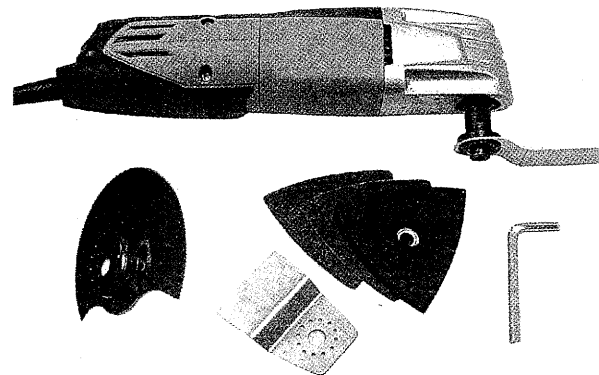

Visit our website at: <http://www.harborfreight.com>



**Read this material before using this product.
Failure to do so can result in serious injury.
SAVE THIS MANUAL.**

Copyright© 2009 by Harbor Freight Tools®. All rights reserved. No portion of this manual or any artwork contained herein may be reproduced in any shape or form without the express written consent of Harbor Freight Tools. Diagrams within this manual may not be drawn proportionally. Due to continuing improvements, actual product may differ slightly from the product described herein. Tools required for assembly and service may not be included.

For technical questions or replacement parts, please call 1-800-444-3353.

SAVE THIS MANUAL

Keep this manual for the safety warnings and precautions, assembly, operating, inspection, maintenance and cleaning procedures. Write the product's serial number in the back of the manual near the assembly diagram (or month and year of purchase if product has no number). Keep this manual and the receipt in a safe and dry place for future reference.

IMPORTANT SAFETY INFORMATION

In this manual, on the labeling, and all other information provided with this product:



This is the safety alert symbol. It is used to alert you to potential personal injury hazards. Obey all safety messages that follow this symbol to avoid possible injury or death.



DANGER indicates a hazardous situation which, if not avoided, will result in death or serious injury.



WARNING indicates a hazardous situation which, if not avoided, could result in death or serious injury.



CAUTION, used with the safety alert symbol, indicates a hazardous situation which, if not avoided, could result in minor or moderate injury.

NOTICE

NOTICE is used to address practices not related to personal injury.

CAUTION

CAUTION, without the safety alert symbol, is used to address practices not related to personal injury.

General Safety Warnings



WARNING Read all safety warnings and instructions. Failure to follow the warnings and instructions may result in electric shock, fire and/or serious injury. Save all warnings and instructions for future reference. The term "power tool" in the warnings refers to your line-operated (corded) power tool.

1. **Work area safety**
 - a. **Keep work area clean and well lit.** Cluttered or dark areas invite accidents.
 - b. **Do not operate power tools in explosive atmospheres, such as in the presence of flammable liquids, gases or dust.** Power tools create sparks which may ignite the dust or fumes.
 - c. **Keep children and bystanders away while operating a power tool.** Distractions can cause you to lose control.
2. **Electrical safety**
 - a. **Power tool Plugs must match the outlet. Never modify the Plug in any way. Do not use any adapter plugs with grounded power tools.** Unmodified plugs and matching outlets will reduce risk of electric shock.

- b. **Avoid body contact with grounded surfaces such as pipes, radiators, ranges and refrigerators.** There is an increased risk of electric shock if your body is grounded.
 - c. **Do not expose power tools to rain or wet conditions.** Water entering a power tool will increase the risk of electric shock.
 - d. **Do not abuse the Power Cord. Never use the Cord for carrying, pulling or unplugging the power tool. Keep Cord away from heat, oil, sharp edges or moving parts.** Damaged or entangled cords increase the risk of electric shock.
 - e. **When operating a power tool outdoors, use an extension cord suitable for outdoor use.** Use of a cord suitable for outdoor use reduces the risk of electric shock.
 - f. **If operating a power tool in a damp location is unavoidable, use a Ground Fault Circuit Interrupter (GFCI) protected supply.** Use of a GFCI reduces the risk of electric shock.
3. **Personal safety**
 - a. **Stay alert, watch what you are doing and use common sense when operating a power tool. Do not use a power tool while you are tired or under the influence of drugs, alcohol or medication.** A moment of inattention while operating power tools may result in serious personal injury.
 - b. **Use personal protective equipment. Always wear ANSI-approved safety goggles.** Safety equipment such as NIOSH-approved dust mask/respirator, NIOSH-approved hear-

ing protection, and heavy duty work gloves will reduce personal injury.

- c. **Prevent unintentional starting. Ensure the Power Switch is in off-position before connecting the power source or picking up carrying the tool.** Carrying power tools with your finger on the Power Switch invites accidents.
 - d. **Remove any adjusting key or wrench before turning the power tool on.** A wrench or a key left attached to an oscillating part of the power tool may result in personal injury.
 - e. **Do not overreach. Keep proper footing and balance at all times!** This enables better control of the power tool in unexpected situations.
 - f. **Dress properly. Do not wear loose clothing or jewelry. Keep your hair, clothing and gloves away from moving parts.** Loose clothing, jewelry or long hair can be caught in moving parts.
4. **Power tool use and care**
 - a. **Do not force the power tool. Use the correct power tool for your application.** The correct power tool does the job better and safer at the rate for which it was designed.
 - b. **Do not use the power tool if the Power Switch does not turn it on and off.** Any power tool that cannot be controlled with the Switch is dangerous and must be repaired.
 - c. **Disconnect the Power Cord from the power source before making any adjustments, changing accessories, or storing the power tool.** Such preventive safety measures

reduce the risk of starting the power tool accidentally.

d. **Store idle power tools out of the reach of children and do not allow persons unfamiliar with the power tool or these instructions to operate the power tool.** *Power tools are dangerous in the hands of untrained users.*

e. **Maintain power tools. Check for misalignment or binding of moving parts, breakage of parts and any other condition that may affect the power tool's operation. If damaged, have the power tool repaired before use.** *Many accidents are caused by poorly maintained power tools.*

f. **Keep cutting accessories sharp and clean.** *Properly maintained cutting accessories with sharp cutting edges are less likely to bind and are easier to control.*

g. **Use the power tool and its accessories in accordance with these instructions, taking into account the working conditions and the work to be performed.** *Use of the power tool for operations different from those intended could result in a hazardous situation.*

5. Service

a. **Have your power tool serviced by a qualified repair person using only identical replacement parts.** *This will ensure that the safety of the power tool is maintained.*

Specific Safety Warnings

1. Maintain labels and nameplates on the power tool. These carry important safety information. If unreadable or missing, contact Harbor Freight Tools for a replacement.
2. CAUTION: Avoid accidental injury. Keep hands and fingers safely away from the oscillating Scraper, Blades, Sanding Pad and Sanding Papers when operating the Tool.
3. Avoid unintentional starting. Prepare to begin work before turning on the power tool.
4. Do not lay the power tool down until it has come to a complete stop. Moving parts can grab the surface and pull the tool out of your control.
5. When using a handheld power tool, maintain a firm grip on the tool with both hands to resist starting torque.
6. Do not leave the power tool unattended when it is plugged into an electrical outlet. Turn off the tool, and unplug it from its electrical outlet before leaving.
7. This product is not a toy. Keep it out of reach of children.
8. People with pacemakers should consult their physician(s) before use. Electromagnetic fields in close proximity to heart pacemaker could cause pacemaker interference or pacemaker failure. In addition, people with pacemakers should:
 - Avoid operating alone.
 - Do not use with power switch locked on.
 - Properly maintain and inspect to avoid electrical shock.

• Any power cord must be properly grounded. A Ground Fault Circuit Interrupter (GFCI) should also be implemented – it prevents sustained electrical shock.

9. Some dust created by power sanding, sawing, grinding, drilling, and other construction activities, contains chemicals known [to the State of California] to cause cancer, birth defects or other reproductive harm. Some examples of these chemicals are:
 - Lead from lead-based paints
 - Crystalline silica from bricks and cement or other masonry products
 - Arsenic and chromium from chemically treated lumberYour risk from these exposures varies, depending on how often you do this type of work. To reduce your exposure to these chemicals: work in a well ventilated area, and work with approved safety equipment, such as those dust masks that are specially designed to filter out microscopic particles.
(California Health & Safety Code § 25249.5, et seq.)
Handling the Power Cord on this product will expose you to lead, a chemical known to the State of California to cause cancer, and birth defects or other reproductive harm. Wash hands after handling.
(California Health & Safety Code § 25249.5, et seq.)
10. The warnings, precautions, and instructions discussed in this instruction manual cannot cover all possible conditions and situations that may occur. It must be understood by the operator that common sense and caution are factors which cannot be built into this

product, but must be supplied by operator.

Vibration Safety

This power tool vibrates during use. Repeated or long-term exposure to vibration may cause temporary or permanent physical injury, particularly to the hands, arms and shoulder. To reduce the risk of vibration-related injury:

1. Anyone using vibrating power tools regularly or for an extended period should first be examined by a doctor and then have regular medical checkups to ensure medical problems are not being caused or worsened from use. Pregnant women or people who have impaired blood circulation to the hand, past hand injuries, nervous system disorders, diabetes, Raynaud's Disease should not use this tool. If you feel any medical symptoms related to vibration (such as tingling, numbness, white or blue fingers), seek medical advice as soon as possible.
2. Do not smoke during use. Nicotine reduces the blood supply to the hands and fingers, increasing the risk of vibration-related injury.
3. Wear suitable gloves to reduce the effects of vibration on the user.
4. Use power tools with the lowest vibration when there is a choice between different processes.
5. Include vibration-free periods each day of work.

- Grip the power tool as lightly as possible (while still keeping safe control of it). Let the tool do the work.
- To reduce vibration, maintain the power tool as explained in this manual. If any abnormal vibration occurs, stop use immediately.

 **SAVE THESE INSTRUCTIONS.**

GROUNDING

 **WARNING** TO PREVENT ELECTRIC SHOCK

AND DEATH FROM INCORRECT GROUNDING WIRE CONNECTION: Check with a qualified electrician if you are in doubt as to whether the outlet is properly grounded. Do not modify the Power Cord Plug provided with the tool. Never remove the grounding prong from the Plug. Do not use the tool if the Power Cord or Plug is damaged. If damaged, have it repaired by a service facility before use. If the Plug will not fit the outlet, have a proper outlet installed by a qualified electrician.

Double Insulated Tools: Tools with Two Prong Plugs

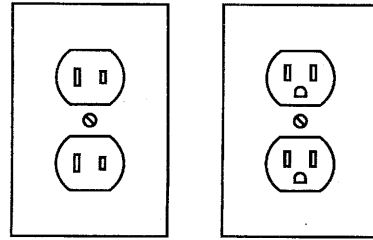

Outlets for 2-Prong Plug

- Tools marked "Double Insulated" do not require grounding. They have a special double insulation system which satisfies OSHA requirements and complies with the applicable standards of Underwriters Laboratories, Inc., the Canadian Standard Association, and the National Electrical Code. (See Outlets for 2-Prong Plug.)
- Double insulated tools may be used in either of the 120 volt outlets shown in the preceding illustration. (See Outlets for 2-Prong Plug.)

Extension Cords





- Grounded tools require a three wire extension cord. **Double Insulated** tools can use either a two or three wire extension cord.
- As the distance from the supply outlet increases, you must use a heavier gauge extension cord. Using extension cords with inadequately sized wire causes a serious drop in voltage, resulting in loss of power and possible tool damage. (See Table A, next page.)

- The smaller the gauge number of the wire, the greater the capacity of the cord. For example, a 14 gauge cord can carry a higher current than a 16 gauge cord. (See Table A.)
- When using more than one extension cord to make up the total length, make sure each cord contains at least the minimum wire size required. (See Table A.)
- If you are using one extension cord for more than one tool, add the nameplate amperes and use the sum to determine the required minimum cord size. (See Table A.)
- If you are using an extension cord outdoors, make sure it is marked with the suffix "W-A" ("W" in Canada) to indicate it is acceptable for outdoor use.
- Make sure the extension cord is properly wired and in good electrical condition. Always replace a damaged extension cord or have it repaired by a qualified electrician before using it.
- Protect the extension cords from sharp objects, excessive heat, and damp or wet areas.

RECOMMENDED MINIMUM WIRE GAUGE FOR EXTENSION CORDS* (120/240 VOLT)					
NAMEPLATE AMPERES (at full load)	EXTENSION CORD LENGTH				
	25'	50'	75'	100'	150'
0 - 2.0	18	18	18	18	16
2.1 - 3.4	18	18	18	16	14
3.5 - 5.0	18	18	16	14	12
5.1 - 7.0	18	16	14	12	12
7.1 - 12.0	18	14	12	10	-

TABLE A * Based on limiting the line voltage drop to five volts at 150% of the rated amperes.

Symbology

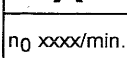
	Double Insulated
	Canadian Standards Association
	Underwriters Laboratories, Inc.
	Volts Alternating Current
	Amperes
	No Load Revolutions per Minute (RPM)

SPECIFICATIONS

Electrical Input	120 V~ / 60 Hz / 2 A
Motor No Load Speed	10,000 - 20,000 OPM
Decibel Level	93-95 dB @ 1m at speed #6 75 dB @ 1m at speed #1
Sanding Pad Dimensions	3" Triangle
Accessories	Sanding Pad (Qty. 1) Sanding Paper (Qty. 2) Cutter Blade (Qty. 1) Scraper (Qty. 1) Half-Circle Blade (Qty. 1) Hex Wrench (Qty. 1) Carbon Brushes (Qty. 2) Molded Storage Case (Qty. 1)

Accessories

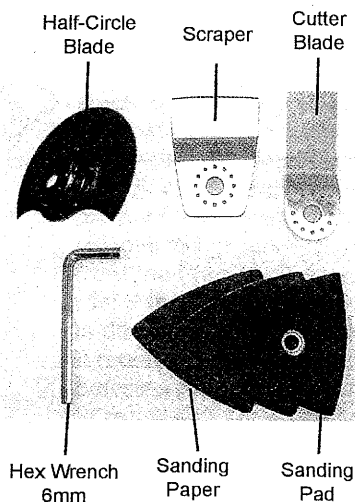

Unpacking

When unpacking, check to make sure that the item is intact and undamaged. If any parts are missing or broken, please call Harbor Freight Tools at 1-800-444-3353 as soon as possible.

Components

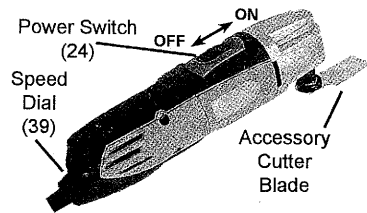

Figure 2

Note: For additional information regarding the parts listed in the following pages, refer to the Assembly Diagram near the end of this manual.

OPERATING INSTRUCTIONS



Read the **ENTIRE IMPORTANT SAFETY INFORMATION** section at the beginning of this manual including all text under subheadings therein before set up or use of this product.

Tool Set Up

WARNING TO PREVENT SERIOUS INJURY FROM ACCIDENTAL OPERATION:
Turn the Power Switch of the tool off and unplug the tool from its electrical outlet before adjusting tool or installing accessories.

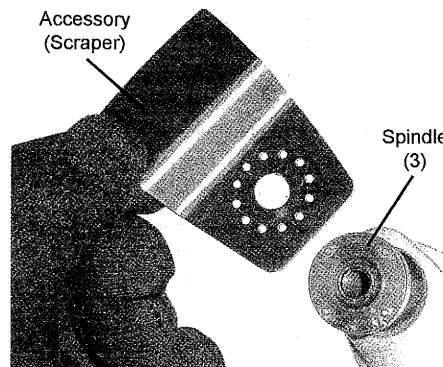
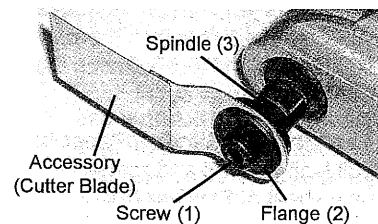

Figure 3

To install an Accessory:

- Unthread the Screw (1), turning it counter clockwise, and remove the Screw and the Flange (2) from the Spindle (3).
- Line up the holes on the Accessory with the four tabs on the Spindle.

Note: When attaching the Cutter Blade or the Scraper, orient the accessory as shown above so the Screw (1) will be out of the way when working.

- Place the cup side of the Flange over the accessory and tighten the Screw into the spindle using the provided hex key. Torque firmly.

Note: For sanding, first attach the Sanding Pad to the tool, then align a Sheet of Sand paper over the pad and press into place.

Note: Accessories may be mounted at angles up to 90° left or right. The accessory should not turn when mounted on the Spindle (3). If it can turn reposition it so that four of the holes on the Accessory line up with the tabs on the Spindle, then tighten Screw (1) securely.

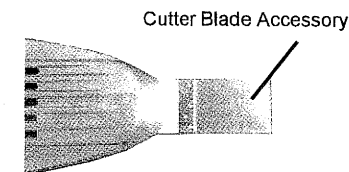

Figure 4

Note: The long Cutter Blade should be used in the straight ahead position as shown above.

Work Piece and Work Area Set

- Designate a work area that is clean and well-lit. The work area must allow access by children or pets to prevent distraction and injury.
- Route the Power Cord (37) along a safe path to reach the work area without creating a tripping hazard or exposing the Power Cord to possible damage. The Power Cord must reach the work area with enough extra length to allow free movement while working.
- Secure loose work pieces using a vise or clamps (not included) to prevent movement while working.

General Operating Instruction

- Wear NIOSH-approved hearing protection and ANSI-approved safety goggles when using this tool.

2. Before each use, check that the accessory is securely seated on the tool with four of the holes on the accessory in place over the four pins on the Spindle (3), and the Screw (1) firmly tightened down.
3. Slide the Power Switch (24) back to its off position. Then plug the Power Cord (37) into the nearest 120 volt, grounded electrical outlet.
4. To turn on the tool, slide the Power Switch (24) forward.
9. When finished, turn off the tool and allow it to completely stop before setting it down. Then unplug the tool from its electrical outlet.
10. To replace the Sanding Paper, simply pull it off the pad and replace with a new sheet of Sanding Paper.
11. Prior to storing the tool, remove the Accessory and wipe it clean. Store the tool in a clean, dry, safe location out of reach of children and other unauthorized persons.

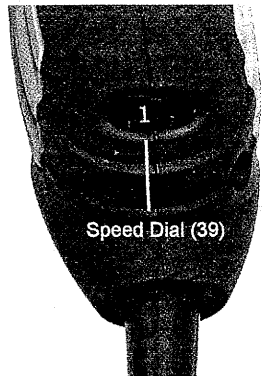

Figure 5

5. Adjust the speed of the tool using the Speed Dial (39). There are six speed divisions from 1 (slowest) to 6 (fastest).
6. Do not allow contact between the Accessory and workpiece until the tool is running at the intended speed.
7. Avoid contact with foreign objects such as metal screws and nails when sanding, scraping, or cutting.
8. Do not apply excessive pressure on the tool. Allow the tool to do the work.

SKU 67537

For technical questions, please call 1-800-444-3353.

MAINTENANCE AND SERVICING



Procedures not specifically explained in this manual must be performed only by a qualified technician.



TO PREVENT SERIOUS INJURY

FROM ACCIDENTAL OPERATION:

Turn the Power Switch (24) of the Tool to its "OFF" position and unplug the tool from its electrical outlet before performing any inspection, maintenance, or cleaning procedures.

TO PREVENT SERIOUS INJURY FROM TOOL FAILURE:

Do not use damaged equipment. If abnormal noise or vibration occurs, have the problem corrected before further use.

1. BEFORE EACH USE, inspect the general condition of the Tool. Check for loose screws, misalignment or binding of moving parts, cracked or broken parts, damaged electrical wiring, and any other condition that may affect its safe operation.

As needed:

- a. Replace the Sanding Paper when it becomes worn or contains excessive debris build-up.
- b. Have the Scraper and Blades sharpened when they become dull.
- c. Have a qualified technician inspect the tool when it malfunctions. The

SKU 67537

For technical questions, please call 1-800-444-3353.

Carbon Brushes (a spare set is included) may need to be replaced.

2. AFTER USE, clean external surface of the tool with clean cloth.

WARNING! If the Power Cord (37) of this Tool is damaged, it must be replaced only by a qualified service technician.

PLEASE READ THE FOLLOWING CAREFULLY

THE MANUFACTURER AND/OR DISTRIBUTOR HAS PROVIDED THE PARTS LIST AND ASSEMBLY DIAGRAM IN THIS MANUAL AS A REFERENCE TOOL ONLY. NEITHER THE MANUFACTURER OR DISTRIBUTOR MAKES ANY REPRESENTATION OR WARRANTY OF ANY KIND TO THE BUYER THAT HE OR SHE IS QUALIFIED TO MAKE ANY REPAIRS TO THE PRODUCT, OR THAT HE OR SHE IS QUALIFIED TO REPLACE ANY PARTS OF THE PRODUCT. IN FACT, THE MANUFACTURER AND/OR DISTRIBUTOR EXPRESSLY STATES THAT ALL REPAIRS AND PARTS REPLACEMENTS SHOULD BE UNDERTAKEN BY CERTIFIED AND LICENSED TECHNICIANS, AND NOT BY THE BUYER. THE BUYER ASSUMES ALL RISK AND LIABILITY ARISING OUT OF HIS OR HER REPAIRS TO THE ORIGINAL PRODUCT OR REPLACEMENT PARTS THERETO, OR ARISING OUT OF HIS OR HER INSTALLATION OF REPLACEMENT PARTS THERETO.

PARTS LIST

Part	Description	Qty
1	Socket Head Screw M8 x 1.25 x 12	1
2	Flange	1
3	Spindle	1
4	Rubber Casing	1
5	Circlip	1
6	Spring Washer	1
7	Bearing 6000	1
8	Block	1
9	Bushing	1
10	Screw ST4 x 25	4
11	Housing Head	1
12	Circlip	1
13	Bearing 625	1
14	Washer	1
15	Cover	1
16	Bearing 608	1
17	Washer	1
18	Armature	1
19	Bearing 607	1
20	Bushing	1
21	Guide	1

Part	Description	Qty
22	Screw ST4.0 x 55	2
23	Stator	1
24	Power Switch	1
25	Link	1
26	Plastic Housing	1
28	Brush Holder	2
29	Carbon Brush	2
30	Rivet	4
31	Screw ST4.0 x 12	2
32	Rear Housing (left)	1
33	Switch	1
34	Brace	1
35	Clip	1
36	Screw ST3.0 x 8	2
37	Power Cord	1
38	Rubber Sleeve	1
39	Speed Dial	1
40	Rear Housing (right)	1
41	Screw ST4.0 x 25	1
42	Screw ST4.0 x 32	2

ASSEMBLY DIAGRAM

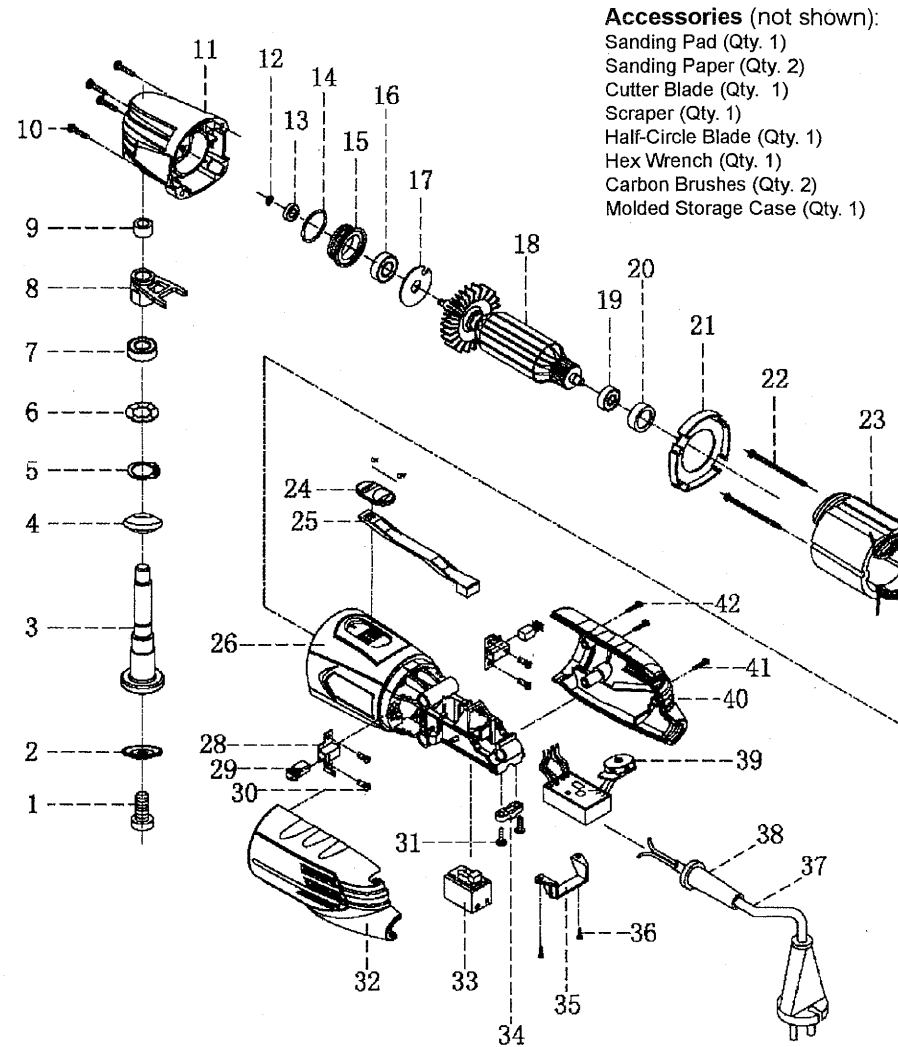

Record Product's Serial Number Here: _____

Note: If product has no serial number, record month and year of purchase instead.

Note: Some parts are listed and shown for illustration purposes only, and are not available individually as replacement parts.

LIMITED 90 DAY WARRANTY

Harbor Freight Tools Co. makes every effort to assure that its products meet high quality and durability standards, and warrants to the original purchaser that this product is free from defects in materials and workmanship for the period of 90 days from the date of purchase. This warranty does not apply to damage due directly or indirectly, to misuse, abuse, negligence or accidents, repairs or alterations outside our facilities, criminal activity, improper installation, normal wear and tear, or to lack of maintenance. We shall in no event be liable for death, injuries to persons or property, or for incidental, contingent, special or consequential damages arising from the use of our product. Some states do not allow the exclusion or limitation of incidental or consequential damages, so the above limitation of exclusion may not apply to you. THIS WARRANTY IS EXPRESSLY IN LIEU OF ALL OTHER WARRANTIES, EXPRESS OR IMPLIED, INCLUDING THE WARRANTIES OF MERCHANTABILITY AND FITNESS.

To take advantage of this warranty, the product or part must be returned to us with transportation charges prepaid. Proof of purchase date and an explanation of the complaint must accompany the merchandise. If our inspection verifies the defect, we will either repair or replace the product at our election or we may elect to refund the purchase price if we cannot readily and quickly provide you with a replacement. We will return repaired products at our expense, but if we determine there is no defect, or that the defect resulted from causes not within the scope of our warranty, then you must bear the cost of returning the product.

This warranty gives you specific legal rights and you may also have other rights which vary from state to state.

3491 Mission Oaks Blvd. • PO Box 6009 • Camarillo, CA 93011 • (800) 444-3353

PROFESSIONAL

CHICAGO ELECTRIC®
POWER TOOLS

VARIABLE SPEED MULTI-FUNCTION TOOL

Model 67537

SET UP AND OPERATING INSTRUCTIONS

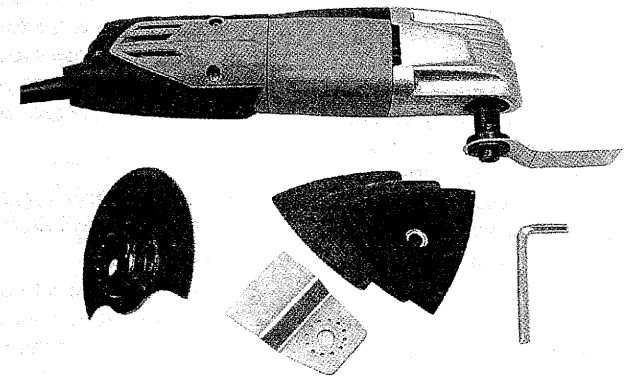

Visit our website at: <http://www.harborfreight.com>



Read this material before using this product.
Failure to do so can result in serious injury.
SAVE THIS MANUAL.

Copyright © 2009 by Harbor Freight Tools®. All rights reserved. No portion of this manual or any art contained herein may be reproduced in any shape or form without the express written consent of Harbor Freight Tools. Diagrams within this manual may not be drawn proportionally. Due to continuing improvements, actual product may differ slightly from the product described herein. Tools required for assembly and service may not be included.

For technical questions or replacement parts, please call 1-800-444-3353.

Manual Revision